



Defense Nuclear Facilities Safety Board

28th Annual Report to Congress xxxx 2018

**Required by Section 2286e(a) of the
Atomic Energy Act of 1954, as amended**

“The mission of the Board shall be to provide independent analysis, advice, and recommendations to the Secretary of Energy to inform the Secretary, in the role of the Secretary as operator and regulator of the defense nuclear facilities of the Department of Energy, in providing adequate protection of public health and safety at such defense nuclear facilities.” 42 U.S.C. § 2286a(a)

Bruce Hamilton, Acting Chairman
Jessie H. Roberson
Daniel J. Santos
Joyce L. Connery

**DEFENSE NUCLEAR FACILITIES
SAFETY BOARD**

Washington, DC 20004-2901



To the Congress of the United States:

The Defense Nuclear Facilities Safety Board (Board) is pleased to submit to Congress its Twenty-Eighth Annual Report for Calendar Year 2017. The Board is an independent executive branch agency responsible for making recommendations to the Secretary of Energy, and in certain cases to the President, to provide adequate protection of public health and safety at the Department of Energy's (DOE) defense nuclear facilities. As required by 42 U.S.C. § 2286e(a), this report describes our current safety initiatives and assesses improvements in the safety of defense nuclear facilities, as well as safety issues yet to be resolved.

Respectfully submitted,

Bruce Hamilton
Acting Chairman

c: The Honorable James Richard Perry

Table of Contents

EX.	Executive Summary.....	i
I.	The Board’s Statutory Mission.....	1
II.	Nuclear Weapon Operations.....	3
III.	Defense Nuclear Waste Operations.....	11
IV.	Design and Construction.....	17
V.	Safety Standards and Programs.....	25
	Appendix A: Board Recommendations.....	27
	Appendix B: Summary of Significant Safety-Related Aging Infrastructure Issues at Defense Nuclear Facilities.....	29



Y-12 National Security Complex

(Intentionally blank)

EX. Executive Summary

Under the Atomic Energy Act of 1954, as amended, the Defense Nuclear Facilities Safety Board (Board) is charged with providing independent safety oversight of the Department of Energy's (DOE) defense nuclear facilities complex—a complex that has served to design, manufacture, test, maintain, and decommission nuclear weapons, as well as other national security priorities. The Act mandates that the Board reviews the content and implementation of DOE standards, facility and system designs, and events and practices at DOE defense nuclear facilities to provide independent analysis, advice, and recommendations to inform the Secretary of Energy in providing adequate protection of public health and safety at DOE defense nuclear facilities.

The Board prioritizes its safety oversight activities predominantly on the basis of risk to the public and workers, types and quantities of nuclear and hazardous material at hand, and hazards of the operations involved. This Annual Report summarizes the Board's significant safety oversight initiatives and some high-priority safety issues at defense nuclear facilities subject to the Board's oversight during 2017. The Board discussed many of these issues in its March 17, 2017, initial letter to Secretary of Energy Perry following his confirmation. Foremost among these initiatives and issues were:

- Emergency Preparedness and Response
- Safety Posture at the Los Alamos National Laboratory Plutonium Facility
- Defense Nuclear Facility Design and Construction Projects
- Safety of Hazardous Waste Cleanup Operations
- Safety of Transuranic Waste Processing and Storage

The agency's staff leadership published new agency-wide requirements, including 12 new Directives and eight new Operating Procedures to reflect changes in law and policy applicable to the agency. The Board implemented Executive Order 13800, *Strengthening the Cybersecurity of Federal Networks and Critical Infrastructure*, before required due dates. The Board also worked with DOE to improve the Board's physical and personnel security posture, including personnel security processing, protection of classified information, and addressing insider threat issues.

This Annual Report organizes the Board's oversight activities into four strategic areas: nuclear weapon operations; defense nuclear waste operations; design and construction of new defense nuclear facilities and major modifications to existing facilities; and safety standards and programs. The table on the following page summarizes substantive 2017 Board communications to DOE. Appendix A summarizes the status of all Board recommendations open in 2017.

Substantive Board Communications to DOE in 2017

TECHNICAL REPORTS	
July 6	Spray Release Accidents at the Hanford Sludge Treatment Project (DNFSB/TECH-41)
October 12	Flammable Gas and Criticality Hazards at the Waste Treatment and Immobilization Plant (DNFSB/TECH-42)
LETTERS	
January 3	Closure of Recommendation 2009-2, <i>Los Alamos National Laboratory Plutonium Facility Seismic Safety</i>
February 16	Concerns with Revision to DOE Implementation Plan for Recommendation 2014-1, <i>Emergency Preparedness and Response</i>
March 17	Summary of the Board's Nuclear Safety Oversight Activities to Secretary
May 10	Concerns with Changes in DOE Order 232.2A, <i>Occurrence Reporting and Processing of Operations Information</i> , with Reporting Requirement
May 11	Safety of the Building 9212 Complex and the Extended Life Program at the Y-12 National Security Complex
June 26	Project Letter on Safety Strategy for the Uranium Processing Facility at the Y-12 National Security Complex
July 25	Progress in Implementation of Recommendation 2015-1, <i>Emergency Preparedness and Response at the Pantex Plant</i>
August 7	Methodology for Safety Integrity Level Determination of Instrumented Systems at the Low Activity Waste Pretreatment System at Hanford
September 13	Designation of Specific Administrative Controls at the Savannah River Site
October 11	Emergency Preparedness and Response at the Los Alamos National Laboratory
October 26	Progress in Implementation of Recommendation 2012-2, <i>Hanford Tank Farms Flammable Gas Safety Strategy</i>
October 27	Weapon Response Technical Basis Documentation for the W80 Weapon Program
November 9	Los Alamos National Laboratory Transuranic Waste Facility Safety Basis
December 13	Closure of Recommendation 2014-1, <i>Emergency Preparedness and Response</i> , with Reporting Requirement
PUBLIC HEARINGS OR MEETINGS	
June 7	Safety Posture of the Plutonium Facility at Los Alamos National Laboratory
September 26	Progress in Implementation of Recommendation 2014-1, <i>Emergency Preparedness and Response</i>

I. The Board's Statutory Mission

Congress established the Board in 1988¹ as an independent federal agency within the executive branch of government, answerable to the President and subject to congressional oversight and direction. Five Board members, appointed by the President subject to confirmation by the Senate, are required to be “respected experts in the field of nuclear safety with a demonstrated competence and knowledge relevant to the independent investigative and oversight functions of the Board.” The Board is a collegial agency, meaning that its actions are determined by the Board as a whole. The Board’s chairman serves as the chief executive officer, and performs this function subject to Board policies.

The Board’s essential mission is to provide independent analysis, advice, and recommendations to the Secretary of Energy to inform the Secretary, in his role as operator and regulator of DOE defense nuclear facilities, in providing adequate protection of public health and safety. As noted above, the Board’s jurisdiction covers DOE’s “defense nuclear facilities” – a term defined in the Atomic Energy Act of 1954, as amended. The Board only is concerned with facilities operated by DOE that are: (1) covered by the Atomic Energy Act; and, (2) have a function related to national defense. The phrase “defense nuclear facilities” thus excludes two major classes of government-regulated nuclear facilities: DOE’s nuclear projects that are civilian in purpose, and commercial nuclear facilities regulated by the Nuclear Regulatory Commission (NRC). The Board’s oversight jurisdiction also does not extend to the U.S. Navy’s nuclear propulsion program or to environmental hazards regulated by other federal and state agencies. (The table on page 2 lists the major sites that the Board oversees.)

The Board’s oversight mission covers all phases in the life of a defense nuclear facility: design, construction, operation, and decommissioning. Congress granted the Board a suite of statutory tools to carry out its mission. Principal among these is the formal Board recommendation issued to the Secretary. The statute requires the Secretary to either accept or reject the Board’s recommendation, and in the case of an acceptance, to write and execute an implementation plan. This process all takes place on the public record. In cases involving an “imminent or severe threat” to the public health and safety, the statute requires the Board to also send its recommendation to the President, who makes the final decision on actions to be taken. In addition to recommendations, the Board is empowered to hold public hearings (and subpoena witnesses, if necessary), conduct investigations, obtain information and documents needed for the Board’s work from DOE and its contractors, and review and comment on DOE requirements and standards affecting safety at defense nuclear facilities. DOE is required by law to grant the Board “ready access to such facilities, personnel, and information as the Board considers necessary to carry out its responsibilities.” Finally, the statute authorizes the Board to seek assistance from other federal agencies (such as NRC) and from organizations outside the government (such as the National Academy of Sciences), as needed.

¹ For more historical information on the factors that caused Congress to establish the Board, see the Board’s 5th Annual Report to Congress, available at: http://www.dnfsb.gov/sites/default/files/Board%20Activities/Reports/Reports%20to%20Congress/1995/ar_1995216_1301.pdf

Major Sites Subject to Board Jurisdiction

Site	Location	Operations	Website
Hanford Site	Richland, Washington	Management and treatment of radioactive wastes; facility decommissioning	http://www.hanford.gov
Idaho National Laboratory	45 miles west of Idaho Falls, Idaho	Storage and processing of radioactive waste	http://www.inl.gov
Lawrence Livermore National Laboratory	Livermore, California	Research to support the nuclear weapons arsenal	https://www.llnl.gov
Los Alamos National Laboratory	Los Alamos, New Mexico	Research to support the nuclear weapons arsenal; manufacturing of nuclear weapon components; disposition of legacy transuranic waste	http://www.lanl.gov
Nevada National Security Site	65 miles northwest of Las Vegas, Nevada	Disposition of damaged nuclear weapons; critical and subcritical experiments; waste management	http://www.nnss.gov
Oak Ridge National Laboratory	Oak Ridge, Tennessee	Energy research; treatment and disposal of radioactive wastes	http://www.ornl.gov
Pantex Plant	17 miles northeast of Amarillo, Texas	Maintenance of the U.S. nuclear stockpile	http://www.pantex.com
Sandia National Laboratories	Albuquerque, New Mexico	Nuclear research; support for the weapons stockpile maintenance program	http://www.sandia.gov
Savannah River Site	Aiken, South Carolina	Tritium extraction, recycling, and storage; management and treatment of radioactive wastes; nuclear materials storage and disposition; research and development	http://www.srs.gov
Waste Isolation Pilot Plant	26 miles east of Carlsbad, New Mexico	Disposal of transuranic waste in underground repository	http://www.wipp.energy.gov/
Y-12 National Security Complex	Oak Ridge, Tennessee	Manufacturing and surveillance of nuclear weapons components; processing of weapons-grade uranium	http://www.y12.doe.gov/

II. Nuclear Weapon Operations

Los Alamos National Laboratory (LANL)

Plutonium Facility Safety Posture

Board Actions

Since January 2009, the Board has transmitted nearly 20 letters/recommendations to DOE regarding the safety posture of the Plutonium Facility at LANL, including Recommendation 2009-2, *Los Alamos National Laboratory Plutonium Facility Seismic Safety*. The Board's 25th, 26th, and 27th Annual Reports to Congress provide more information and summarize the Board's concerns.

On January 3, 2017, the Board voted to close Recommendation 2009-2 because DOE's implementation plan no longer addressed the current state of safety at the Plutonium Facility. The Board noted that since it issued the recommendation, DOE has made, and continues to make, numerous upgrades to improve the Plutonium Facility's capability to withstand the evaluation-basis seismic hazard. However, the Board still had significant questions regarding the suitability of the Plutonium Facility for long term operations, the adequacy of the fire suppression system, and opportunities to further reduce material-at-risk in the facility.

On June 7, 2017, the Board held a public hearing in New Mexico to better understand the safety posture of the Plutonium Facility. The goals of this public hearing were to gather information on (1) the risk associated with current and future Plutonium Facility inventory levels, (2) actions taken by the National Nuclear Security Administration (NNSA) and LANL to address opportunities identified by the Board to minimize material-at-risk, (3) actions to reduce facility risk for long-term operations, and (4) the adequacy and status of safety systems to support current and long term operations. The Board received testimony and held panel discussions with personnel from NNSA, NNSA's Los Alamos Field Office, and the LANL contractor.

Staff Review

During 2017, the Board's staff began a detailed review of the documented safety bases, technical safety requirements, and safety posture of the Plutonium Facility. This activity will continue into 2018.

Inappropriately Remediated Nitrate Salt Waste

DOE attributed the February 14, 2014, radiological release event at the Waste Isolation Pilot Plant (WIPP) to LANL transuranic (TRU) waste drums that contained what is now termed "inappropriately remediated nitrate salt (RNS) waste." Since that time, LANL personnel have expended significant effort to safely treat the 60 RNS waste containers identified on site at LANL

and relocated to Dome 375 at Area G. The Board and its staff interacted closely with NNSA and LANL personnel to ensure all aspects of safety were considered while urgently preparing to treat the hazardous waste. In November 2017, LANL completed the treatment process in a safe and deliberate manner, resulting in the elimination of a substantial hazard at LANL. LANL also began a campaign to treat “unremediated nitrate salt” waste, similar to RNS waste, but not previously treated with organic absorbent material. During 2017, the Board’s staff also provided oversight during readiness preparations and treatment activities associated with this follow-on process.



Unremediated Nitrate Salt Waste Processing at LANL

LANL Emergency Preparedness & Response

In January 2016, the Board transmitted to the Secretary of Energy a letter that identified weaknesses with the implementation of a comprehensive training and drill program for emergency response at LANL. Since that time, the Board’s staff performed an onsite review of LANL’s emergency preparedness and response program and observed numerous drills and exercises. Based on data developed as a result of the review and observations, the Board sent a Draft Recommendation discussing LANL emergency preparedness and response to the Secretary of Energy on February 21, 2017. On behalf of the Secretary, the NNSA Administrator responded to the Board on March 23, 2017, outlining “a number of actions and activities completed and underway by NNSA and LANL aimed at continuous improvement of the Emergency Management

program at Los Alamos.” In a letter dated July 13, 2017, the Board declared that it decided not to transmit a final recommendation regarding emergency preparedness and response at LANL.

On October 11, 2017, the Board followed up on the issue, transmitting a staff report identifying several weaknesses in LANL’s emergency preparedness and response capabilities in selected areas, including: LANL’s demonstrated emergency response in drills and exercises, LANL’s site emergency exercise program, LANL’s facility-level emergency programs, and NNSA’s federal oversight.

Nuclear Criticality Safety

Since the Board’s 24th Annual Report to Congress, dated March 2014, LANL has continued to make progress in resuming operations that were paused at the Plutonium Facility and has been addressing long-standing deficiencies within its nuclear criticality safety program. In 2017, the LANL contractor declared the formal resumption plan completed. Beyond the scope of the formal plan, the contractor completed readiness preparations and restarted aqueous chloride and americium oxide operations. At the end of 2017, the contractor was completing readiness preparations for electro-refining operations. The Board’s staff provided oversight of all of these activities.

While LANL has made improvements in its nuclear criticality safety program, DOE’s *Annual Metrics Report on Nuclear Criticality Safety Programs*, dated February 1, 2017, noted that LANL’s program does not meet expectations with regard to applicable DOE and industry standards. Reinforcing these conclusions, in August 2017, LANL operators violated a criticality safety glovebox mass limit during heat treatment operations, in part because they did not precisely follow a use-every-time attachment to a material movement procedure. In 2017, the Board’s staff began a review of LANL’s nuclear criticality safety program to independently assess the health of the program and determine the status of LANL initiatives to address concerns previously communicated by the Board in its letter dated July 15, 2013. This work continues into 2018.

Pantex Plant

Nuclear Explosive Bay and Cell Structures and Systems

Nuclear Explosive Cells Structural Reviews—The Board’s staff reviewed corrective actions taken by the Pantex Plant contractor to address a faulty repair in the structural slab of two nuclear explosive cells, which was identified based on inquiry by the Board’s staff in 2016. Pantex repaired the slab as part of fire water lead-in repairs in the cells; however, the slab repair did not meet nuclear quality assurance requirements and had inadequate structural strength. Subsequently, the Pantex Plant contractor completely removed the structural steel and concrete installed during the first attempted repair and implemented a commercial grade dedication program for the follow-on repair. Beginning in 2016 and through 2017, the Board’s staff observed and evaluated the program, including reviewing quality assurance and testing documentation and

observing structural steel splice installation and concrete placement. The Pantex Plant contractor plans to use lessons learned from these repair efforts in future repairs at nuclear facilities.

Maintenance Systems Review—In December 2017, the Board’s staff and an accompanying Board member conducted an onsite review of the Pantex Plant maintenance and cognizant system engineering programs. The review focused on establishing whether Pantex Plant safety-related structures, systems, and components are being managed and maintained in such a way that they will operate when needed and as designed. Additionally, the review followed up on issues identified in the Board’s letter of November 12, 2015. The Board’s staff will continue evaluation of data in 2018.

Fire Protection Systems Review—In late 2016, the Pantex Plant contractor identified the absence and inaccessibility of fire dampers in ventilation ducting that penetrates credited fire barriers. Pantex initiated a corrective action plan to validate the location of all fire dampers in nuclear material and nuclear explosive areas of the plant. Pantex discovered additional missing dampers in the vacuum chamber facility, a nuclear explosive area. A Board member and Board’s staff reviewed affected areas, monitored progress toward completion of the validation initiative, and discussed with Pantex personnel the site’s plans to ensure the technical basis is adequate for areas of the plant where fire dampers were previously determined to be unnecessary. The validation initiative continues into 2018.



Nuclear Explosive Facilities at the Pantex Plant

Nuclear Explosive Safety

Throughout 2017, the Board's staff provided oversight of nuclear explosive operations at the Pantex Plant, including NNSA's efforts to implement revised nuclear explosive safety directives at the design agencies and production plants. The Board's staff observed the evaluations of nuclear explosive safety for the W76, including Mod 0 and Mod 1; the W80, including ALT 369 and 397; W78 units requiring repair; and W88 disassembly and inspection and rebuild operations. Additionally, the Board's staff evaluated implementation of a new electrical tester on the W87 and W88 programs.

In 2017, the design agencies discovered that certain weapon programs were at risk from the potential for pneumatic hose whip impacts during assembly and disassembly of units. The Board's staff evaluated the change in the control suite necessary to ensure that the Pantex Plant contractor could safely perform operations on these units.

The Board's staff observed the nuclear explosive safety evaluation of the electrical tester program that covers the design, manufacturing, qualification, and fielding of equipment that may connect to the electrical circuitry of our nation's nuclear arsenal. The Board's staff also observed various other evaluations of changes to the nuclear explosive safety control suite, including evaluations following the identification of abnormal configurations of lighting installed in nuclear explosive facilities and abnormal results obtained during mechanical safe and arm detonator testing.

Special Tooling and "Falling Man" Scenarios

In September 2017, the Board's staff concluded a review of the Pantex Plant special tooling program, including safety basis integration, flow down of functional requirements, technical support documentation and analyses, preventive maintenance and in-service inspections of special tooling, and quality assurance requirements and processes. The Board's staff evaluated the special tooling program and its ability to ensure that credited pieces of special tooling are adequately designed, fabricated, and inspected, ensuring their ability to perform safety significant and/or safety class functions.

During the review, the staff evaluated more than 75 special tooling designs, including a vertical slice of special tooling for the B61 program and a horizontal slice of common special tooling designs across weapon programs (e.g., vacuum lifting fixtures). Following the review, the Pantex contractor identified actions to improve the special tooling design manual and engineering analyses.

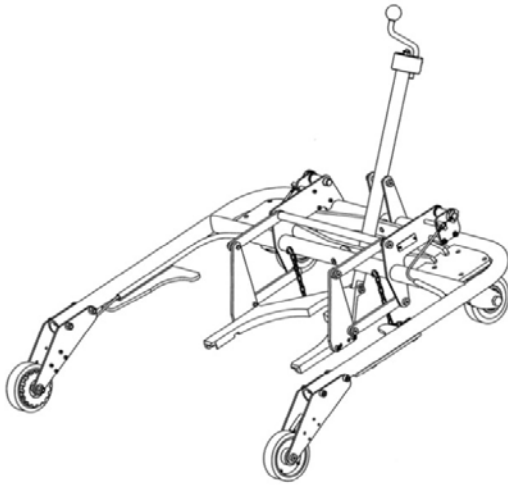

Transfer Cart

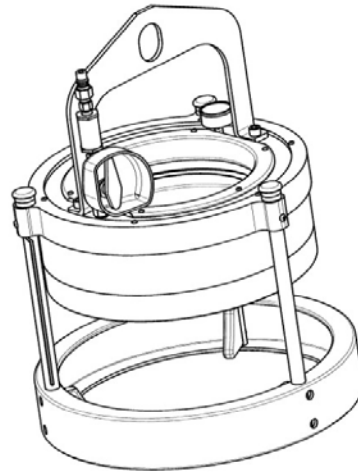

Vacuum Lifting Fixture

Special Tooling Examples at the Pantex Plant

In a letter dated June 2, 2014, the Board identified a concern that NNSA had not demonstrated that special tooling used in nuclear explosive operations at Pantex adequately protects the public and workers from the potential consequences of a worker falling into special tooling or a nuclear explosive. Subsequently, NNSA chartered the Weapons Complex Falling Man Committee in 2015. In September 2017, the committee released the newly developed Falling Man Event Model. NNSA is currently evaluating options to make use of the model. Since the committee's inception, the Board's staff has closely followed this effort.

Y-12 National Security Complex (Y-12)

Enriched Uranium Strategy

Board Actions

Extended Life Program and the Continued Safe Operating Oversight Team—NNSA's enriched uranium strategy includes ceasing enriched uranium programmatic operations in the 9212 Complex by 2025, while implementing an extended life program to maintain safe operations in Building 9204-2E and the 9215 Complex through at least 2040. In 2007, the Board established an annual reporting requirement regarding the condition and continued safe operations of the 9212 Complex. NNSA subsequently expanded the report to include discussions of the condition of Building 9204-2E and the 9215 Complex, in addition to the 9212 Complex. In a May 11, 2017, letter to NNSA, the Board terminated the annual reporting requirement, citing the extended life

program and its associated safety strategy for helping mitigate the risks associated with aging infrastructure at the Y-12 National Security Complex.

Staff Review

Nuclear Facilities Electrical Modernization—NNSA is implementing a Nuclear Facility Electrical Modernization project to upgrade aging electrical equipment in Building 9204-2E and the 9215 Complex as part of its effort to improve operational safety in these facilities. The Board's staff reviewed the electrical distribution systems in Building 9204-2E and the 9215 Complex, as well as ongoing and planned improvements that are part of the Nuclear Facility Electrical Modernization scope.

Facility Safety Bases

The Y-12 extended life program safety strategy includes a roadmap for revising the safety bases of Building 9204-2E and the 9215 Complex. In 2016, NNSA revised the Building 9204-2E safety basis to consolidate supporting analyses and incorporate modern control classification thresholds, although it deferred significant changes to supporting analyses. In 2017, the Board's staff reviewed the Building 9204-2E safety basis and made observations related to control classification, evaluation basis accidents, and various engineered and administrative controls. In a related effort, the Board's staff reviewed certain Y-12 processes used to manage and maintain facility safety bases, including the unreviewed safety question determination procedure.

Savannah River Tritium Enterprise

Tritium Extraction Facility Safety Basis

In a January 7, 2016, letter to NNSA, the Board identified three safety issues regarding the safety basis for the Tritium Extraction Facility: (1) new controls may be needed to protect collocated workers for some accident scenarios following implementation of new atmospheric dispersion parameters; (2) the tritium control rooms have no remote indication of the tank level for the fire suppression system water supply; and (3) the Tritium Extraction Facility safety basis inappropriately credits safety management programs for specific risk reductions in the hazard analysis. In January 2017, facility personnel installed and tested engineered systems to address the issue with tank level indication.

In July 2017, the facility contractor submitted a revision to the safety basis that combined several tritium facilities, and their material-at-risk, into one safety basis. At the end of 2017, NNSA was evaluating the revised safety basis that includes the new atmospheric dispersion parameters, no longer credits the Emergency Preparedness Program to mitigate accident scenarios, and invokes limits to reduce the material-at-risk by approximately 50 percent at the tritium facilities. The Board's staff continues its review of the revised safety basis into 2018.

Lawrence Livermore National Laboratory (LLNL)

Weapon Response Technical Basis

In April 2017, the Board's staff concluded its review of the technical basis documents underpinning the W80 weapon response—used as a key input for development of the W80 documented safety analysis for operations at the Pantex Plant. The Board's staff reviewed the weapon response technical basis and identified opportunities for improvement. These opportunities included bolstering the guidance to LLNL contractor staff in performing extent-of-condition reviews across other weapon programs and improving the language used to determine the maturity of new and developing weapon response information. During the review, the Board's staff also identified opportunities for improving the technical basis documentation itself, applicable to either the next revision of the documents or when implementing the recently updated DOE Standard 3016–2016, *Hazard Analysis Reports for Nuclear Explosive Operations*. The Board issued a letter to NNSA on October 27, 2017, forwarding the findings of the staff's review. At the end of 2017, NNSA was evaluating the improvements identified in the Board's letter for potential implementation.

Nevada National Security Site (NNSS)

National Criticality Experiment Research Center (NCERC) Instrumentation & Control (I&C)

In August 2010, the Board sent a letter to NNSA that provided the results of a review of the safety basis for NCERC. In January 2017, the Board's staff completed a follow-up review and found that NNSA had resolved the issues related to I&C systems design identified in the Board's letter.

III. Defense Nuclear Waste Operations

Savannah River Site (SRS)

Designation of Specific Administrative Controls

In a September 13, 2017, letter to DOE, the Board expressed concern that the safety bases at several SRS defense nuclear facilities inappropriately rely on programmatic administrative controls to perform credited safety functions in lieu of more rigorous specific administrative controls (SACs). Without designation as SACs, the requirements and guidance promulgated by DOE for providing assurance of the reliability and effectiveness of these important administrative controls do not apply. The Board highlighted that this practice is inconsistent with DOE requirements and expectations and can lead to inadequate safety controls for nuclear hazards at SRS.

K-Area Complex Plutonium Down-Blend Operations

In November 2016, the Board's staff reviewed the K-Area Complex's safety basis changes to support a new plutonium oxide down-blend process. DOE applied an atmospheric dispersion model with known deficiencies resulting in under-predicting the radiological consequences to the public from postulated accidents such as fires. In 2017, DOE eliminated major fire hazards from the K-Area Complex to reduce the potential radiological consequences and accelerated the schedule for updating the accident analysis with the corrected atmospheric dispersion model. DOE has incorporated the changes addressing fire hazards in the K-Area Complex safety basis.



K-Area Complex Glovebox Operations

Solid Waste Management Facility

The Board's staff reviewed the safety basis for the Solid Waste Management Facility, which provides storage, processing, and disposal capabilities for radiological waste at SRS.

Hanford Site

Deactivation and Decommissioning of the Plutonium Finishing Plant (PFP)

In 2017, the Board's staff oversight of ongoing demolition activities at the heavily contaminated PFP structure focused on direct observation of work plan development and execution. The Board's staff observed work plan reviews and the subsequent execution of the work plans. The Board staff's oversight primarily was targeted at periods of initiation and transition in demolition activities between the various PFP structures. In December 2017, DOE suspended demolition activities at PFP following a spread of contamination beyond radiologically controlled areas. The Board and its staff are reviewing the event and monitoring DOE's response.



Demolition of the Hanford Plutonium Finishing Plant

PUREX Tunnel Collapse

On May 9, 2017, PUREX Tunnel #1 partially collapsed, exposing a section of the tunnel to the atmosphere. DOE and its contractors backfilled the breach with soil as an initial response to the incident, and then began plans to fill the tunnel with grout as a long-term solution. The Board's staff reviewed the collapse and subsequent recovery operations. An onsite review by the Board's staff in September 2017 examined the structural and radiological aspects of proposed remediation actions prior to the start of grouting operations.



Partial Collapse of PUREX Tunnel #1

Hanford Building 324 Decontamination

Building 324, the Waste Technology Engineering Laboratory, operated from 1965 to 1996 in support of materials and chemical process research and development. Over this time, a breach in the sump below B-cell resulted in the migration of radioactive materials into the soil beneath the cell. The Board's staff is reviewing the plans and preparations for the remediation of the contaminated soil below Building 324's B-cell. The Board's staff reviewed the radiological hazards associated with the removal of contaminated soil, including project plans to mitigate risks. At the end of 2017, the Board's staff was reviewing the structural implications of soil removal on Building 324 and changes to its safety basis and will continue this review into 2018.

Waste Encapsulation and Storage Facility (WESF) Dry Storage

WESF is a 40-year-old facility that stores highly radioactive cesium and strontium capsules in a pool. DOE has hired a contractor to design and build a capsule dry storage system, and is expected to have a final design completed in 2018. At the end of 2017, the Board’s staff was reviewing the plans developed by the contractor for preliminary design of the capsule dry storage system and will continue this review into 2018.

Longevity and Continued Operations of Hanford’s High-Level Waste Storage Systems

DOE stores more than 50 million gallons of high-level radioactive waste in 177 underground tanks at the Hanford site. In 2012, DOE identified a slow but continuing leak from the primary (inner) tank of double-shell tank AY-102. During 2017, the Board’s staff closely monitored DOE’s retrieval of waste from AY-102. DOE also completed retrieval of waste from tank C-105, the last remaining active tank in C-Farm. DOE is currently developing a path forward for long-term tank closure.

Idaho National Laboratory (INL)

Advanced Mixed Waste Treatment Project (AMWTP) Safety Basis Implementation

In September 2017, the Board’s staff reviewed the implementation of safety controls defined in the safety basis for the AMWTP.



Stored Repackaged Waste Drums at AMWTP

Oak Ridge National Laboratory (ORNL)

Transuranic Waste Processing Center Safety Basis Review

During 2017, the Board's staff reviewed the safety basis for the Transuranic Waste Processing Center at ORNL. This review covered the following topics: hazard identification, accident analysis, control selection, and adherence to relevant DOE directives. At the end of 2017, DOE was taking actions to address the robustness of the control set for a fuel pool fire started by a diesel truck accident.

National Transuranic Waste Program

Waste Acceptance Criteria and Basis of Knowledge

Following the February 2014 radiological release event at WIPP, DOE began an effort to revise the WIPP Waste Acceptance Criteria (WAC) to improve existing requirements and to establish new requirements. In 2017, DOE completed development of evaluation criteria for the WIPP WAC that are derived from testing of oxidizing material mixed with absorbents that are commonly used to treat TRU waste. The Board's staff reviewed these changes to the WIPP WAC requirements as they were developed and implemented. Initial shipments to WIPP from TRU waste generator sites across the DOE Complex have involved waste streams that were not expected to be substantially impacted by the new WIPP WAC. The Board's staff is monitoring DOE's progress in continuing the implementation of the revised WIPP WAC.

Waste Isolation Pilot Plant

DOE suspended operations at WIPP in February 2014 as a result of a fire involving an underground vehicle and a radiological release event caused by a chemical reaction in a waste drum emplaced in the underground. Waste disposal at WIPP is essential to eliminate the risks posed by TRU waste stored across the DOE defense nuclear complex. WIPP resumed waste disposal operations in January 2017. The Board increased its safety oversight to verify that the recovery actions were sufficient and that waste disposal was safely resumed.

Through 2017, the Board's staff provided periodic routine oversight of waste disposal, including conduct of operations, maintenance practices and planning, and safety-significant system design. The Board's staff reviewed the WIPP radiation protection program, and observed the contractor and DOE readiness assessments for startup of the WIPP supplemental ventilation system (SVS). Oversight of the new Safety Significant Confinement Ventilation System being designed by DOE is discussed in section IV.



Waste Isolation Pilot Plant

WIPP experienced several unplanned roof falls near the end of 2016 as a result of the lack of mine maintenance during the operational suspension. As a result of the roof falls and abandoning unmaintained areas of the mine, WIPP has lost some waste placement capacity. WIPP continues to encounter challenges with limited mine ventilation that preclude mine maintenance operations simultaneously with waste placement.

IV. Design and Construction

On July 24, 2017, the Board published Policy Statement-6, *Policy Statement on Oversight of Design and Construction of Defense Nuclear Facilities*. This policy statement establishes the approach the Board takes to review the design and construction of DOE defense nuclear facilities. In particular, it provides the basis for prioritizing independent oversight activities, the Board’s approach to executing reviews with defined scope and durations, and the Board’s approach to evaluating and communicating safety information to DOE and the public.

This policy directs the Board’s staff to prepare formal reports at specified and logical points in DOE’s design and construction process. These reports document analyses of conceptual design, final design, construction, and commissioning of new defense nuclear facilities and major modifications to existing defense nuclear facilities. The Board’s evaluation of staff analyses presented in these reports, along with other sources of data such as input from resident inspectors, Board Member field visits, DOE project status briefings, and Board hearings, form the basis for identifying any nuclear safety deficiencies to DOE. Commensurate with the degree a deficiency challenges adequate protection of public health and safety, the Board uses its statutory tools to inform DOE and the public. Design and construction projects under review by the Board and its staff are listed in the following table.

Table - Design and Construction Projects under Review in 2017

Project Name	Location	Status of Project	Status of Board Review
Waste Treatment and Immobilization Plant	Hanford Site, Richland, WA	Concurrent design and construction	Ongoing - multiple open safety issues Board letter issued 10/12/2017
K-Basin Closure Sludge Treatment Project	Hanford Site, Richland, WA	Phase 1: Construction Phase 2: Conceptual design	Ongoing - no current safety issues Board letter issued 7/6/2017
Low Activity Waste Pretreatment System	Hanford Site, Richland, WA	Preliminary design	Ongoing - project letter issued 5/14/2015
Tank Waste Characterization and Staging Capability	Hanford Site, Richland, WA	Conceptual design	Ongoing - no current safety issues

Project Name	Location	Status of Project	Status of Board Review
Idaho Calcine Disposition Project	Idaho National Laboratory, Idaho Falls, ID	Conceptual design	Ongoing - no current safety issues
Transuranic Waste Facility Project	Los Alamos National Laboratory, Los Alamos, NM	Operational	Ongoing - Board letter issued 11/09/2017
Plutonium Equipment Installation Subproject Phase 1	Los Alamos National Laboratory, Los Alamos, NM	Construction	Ongoing - project letter issued 11/18/2016
Transuranic Waste Processing Center Sludge Processing Facility Buildouts	Oak Ridge National Laboratory, Oak Ridge, TN	Preliminary design	Ongoing - no current safety issues
Material Staging Facility	Pantex Plant, Amarillo, TX	Conceptual design	Ongoing - no current safety issues
Salt Waste Processing Facility	Savannah River Site, Aiken, SC	Construction complete	Ongoing - reviewing facility startup
Safety Significant Confinement Ventilation System	Waste Isolation Pilot Plant, Carlsbad, NM	Final design	Ongoing - no current safety issues
Uranium Processing Facility	Y-12 National Security Complex, Oak Ridge, TN	Preliminary design	Ongoing - no current safety issues, project letter issued 6/26/2017
Electrorefining Project	Y-12 National Security Complex, Oak	Preliminary design	Ongoing - no current safety issues

Hanford Site, Waste Treatment and Immobilization Plant/Low Activity Waste Pretreatment System

The tank farms at the Hanford Site near Richland, Washington, contain 56 million gallons of radioactive and toxic waste stored in 177 underground tanks. In the late 1990s, DOE began work on the Waste Treatment and Immobilization Plant (WTP) intended to immobilize the

Hanford tank waste. WTP is a radiochemical processing plant consisting of four primary facilities: the Analytical Laboratory, Low-Activity Waste (LAW), High-Level Waste (HLW), and Pretreatment Facilities. As initially designed, all waste first would be processed through the Pretreatment Facility, where it would be separated into two streams: low-activity waste and high-level waste. The two waste streams then would be solidified into glass in stainless steel containers at the LAW and HLW Facilities. DOE will dispose of the low-activity waste glass onsite and will ship the high-level waste glass offsite for permanent disposal once a national repository is available.

In 2012, DOE restricted engineering, procurement, and construction work on the Pretreatment and HLW Facilities because of unresolved technical and safety issues and misalignment between the design and the nuclear safety basis. DOE directed its contractor to address open issues before DOE would authorize resuming engineering, procurement, and construction work for these facilities. On August 19, 2014, DOE authorized the contractor to resume engineering work to finalize the design of the HLW Facility, with limited procurement and construction. However, a considerable amount of work still remained to resolve the open issues.

In 2016, DOE developed resolution strategies for three longstanding technical issues, which address four out of fifteen Board open safety issues: generation and accumulation of hydrogen in the Pretreatment Facility process vessels; heat transfer analyses for process vessels; criticality in process vessels; and hydrogen in pipes and ancillary vessels. The strategies include the development of a standard vessel design with demonstrated mixing performance to handle slurries with high solids content in the Pretreatment Facility. In December 2016, DOE initiated full-scale testing of the vessel design.



Waste Treatment and Immobilization Plant, Hanford Site

To mitigate delays from technical and safety issues with the HLW and Pretreatment facilities, DOE developed a strategy to feed the liquid portion of the Hanford tank waste to the LAW Facility without first processing it in the Pretreatment Facility. This approach includes a new project—the Low-Activity Waste Pretreatment System (LAWPS)—that will pretreat and deliver waste to the LAW Facility. This strategy would enable the LAW Facility to begin vitrifying waste before completion of the Pretreatment Facility.

DOE continued to make progress on the LAWPS design, achieving the 60-percent design milestone, as well as sustaining work towards resolving longstanding technical and safety issues. DOE contractors concluded full-scale testing of the control systems for the pulse-jet mixers and the standard vessel design. DOE approved the revised safety basis for the HLW Facility and authorized the contractor to resume procurement and construction. The HLW Facility safety basis included resolution strategies for the following Board open safety issues: unanalyzed melter accident scenarios, hydrogen control strategy for HLW Facility process vessels, and seismic classification of the confinement ventilation system.

In 2017, the Board's staff focused on evaluating LAWPS and DOE's work to resolve open Board safety issues. The methodology approved by DOE for determining the safety integrity level of LAWPS instrumented systems does not provide a level of safety equivalent to that prescribed in industry consensus standards invoked by DOE orders. In an August 7, 2017, letter, the Board informed DOE that, although application of the alternative methodology at LAWPS poses no safety concerns, a similar application to other facilities may yield unacceptable consequences.

In addition, the Board's staff analyzed DOE's proposed control strategy to address safety issues associated with flammable gas and criticality hazards in the Pretreatment Facility. In an October 12, 2017, letter, the Board provided Technical Report, DNFSB/TECH-42, *Flammable Gas and Criticality Hazards at the Waste Treatment and Immobilization Plant*, to DOE for information and use. The report identifies deficiencies in DOE's proposed control strategies and provides the technical basis for the Board conclusions.

Y-12 National Security Complex, Uranium Processing Facility (UPF)

Enriched uranium processing and fabrication are vital to maintaining the Nation's nuclear weapons stockpile and supplying fuel for the United States Navy's nuclear-powered warships. NNSA's current modernization strategy calls for replacing certain capabilities from the aging 9212 Complex at Y-12 by 2025. Under the UPF Project, NNSA will install these capabilities in multiple facilities segregated by safety risk and security requirements.



Artist's Rendering of the Uranium Processing Facility, Y-12 National Security Complex

In 2017, the UPF Project reached the final design stage in preparation for its upcoming submittal for Critical Decision-2/3 in January 2018. NNSA also approved the Preliminary Documented Safety Analysis, which describes the facility hazards during design, construction, and operation, and prescribes operating and engineering safety controls.

The Board issued a project letter to DOE on June 26, 2017, that documented its evaluation of the UPF project. The letter identified three opportunities for improvement related to the fire safety strategy aspect of the design. NNSA responded in an October 13, 2017, letter, which described the on-going implementation status of the opportunities for improvement that the Board had identified.

Los Alamos National Laboratory, Transuranic Waste Facility

NNSA recently completed the new Transuranic Waste Facility. The new facility will be capable of staging and storing up to 1,240 drums of waste created by the enduring missions at Los Alamos National Laboratory. In addition, its characterization function will certify that waste containers meet the acceptance requirements for shipment to and disposal at WIPP.



Transuranic Waste Facility, Los Alamos National Laboratory

NNSA personnel performed an Operational Readiness Review (ORR) from July to September 2017 to confirm the Transuranic Waste Facility's readiness to safely start operations. The Board's staff observed key portions of the ORR. NNSA subsequently approved a phased startup of nuclear operations and issued approval of Critical Decision 4, *Project Completion*, on September 28, 2017.

As communicated to NNSA in its November 9, 2017, letter, the Board agrees that the Transuranic Waste Facility is safe to perform operations under conditions approved by NNSA in the Safety Evaluation Report. However, a number of concerns remain related to the facility's hazards analysis and derived controls for subsequent phases of operations. The Board understands that NNSA plans to complete a significant revision of the facility Documented Safety Analysis in 2018.

Savannah River Site, Salt Waste Processing Facility

The Salt Waste Processing Facility will separate SRS tank farm waste into high-level and low activity waste streams. The high-level waste stream will be vitrified at the Defense Waste Processing Facility. The low activity waste stream will be immobilized into a grout mixture at the Saltstone Production Facility. DOE completed construction in April 2016 and is now conducting non-radiological system and facility testing to support commissioning and startup in 2018.

In 2017, the Board's staff reviewed testing of the instrumentation and controls system associated with all safety instrumented functions. At the end of 2017, DOE was taking action to re-perform the testing of the instrumentation and control system based on revised testing procedures. The Board's staff will continue to monitor facility testing to support commissioning and startup.



Salt Waste Processing Facility, Savannah River Site

Waste Isolation Pilot Plant Safety Significant Confinement Ventilation System

DOE approved CD-1, *Approve Alternative Selection and Cost Range*, on December 23, 2015, for the Permanent Ventilation System Project at WIPP and is currently completing the final design for the project. Subsequently renamed the Safety Significant Confinement Ventilation System, it will play a critical role in restoring sustainable operations at WIPP. DOE expects to approve a combined Critical Decision (CD)-2, *Approve Performance Baseline*, and CD-3, *Approve Start of Construction*, in early 2018.

The new system will have a much larger capacity for filtering air from the underground waste storage area than the existing ventilation system and allow for more maintenance and operational flexibility. Additionally, the design includes a salt reduction system and an option that allows for unfiltered exhaust from the waste disposal area that automatically switches to high-efficiency-particulate-air filtration upon detection of airborne radioactive contamination.

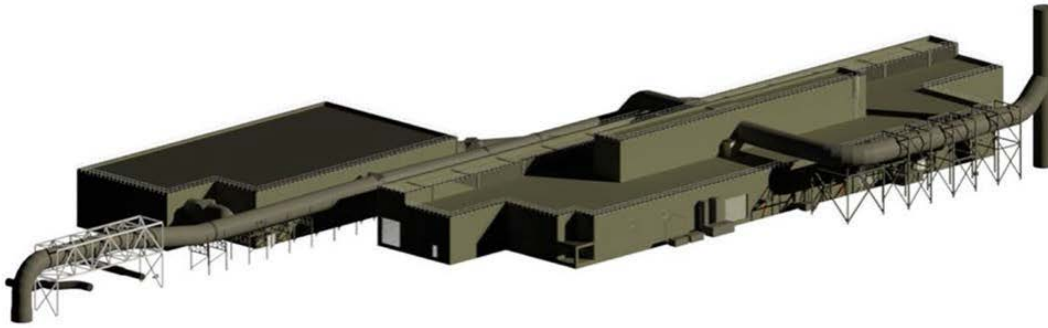

WIPP Safety Significant Confinement Ventilation System

By the end of 2017, this project completed 90 percent design. The Board's staff has continued to closely follow its progress. The ongoing focus of the Board's staff's review efforts is the potential for reliability problems, as highlighted in the Board's February 19, 2016, project letter to DOE.

Hanford Site, Sludge Treatment Project

In a July 6, 2017, letter, the Board provided Technical Report, DNFSB/TECH-41, *Spray Release Accidents at the Hanford Sludge Treatment Project*, to DOE for information. The report contains an assessment of spray release accidents for the Hanford Sludge Treatment Project Engineered Container Retrieval and Transfer System (ECRTS). In its letter, the Board concurred that the control set for spray release accidents, as documented in the ECRTS preliminary documented safety analysis, provided adequate protection for the public.

V. Safety Standards and Programs

Department of Energy Directives

The Board evaluates the content and implementation of DOE directives relating to the design, construction, operation, and decommissioning of DOE's defense nuclear facilities. The Board is required to review these directives, termed as "standards" in the Atomic Energy Act, which include DOE orders, guides, regulations, technical standards, and handbooks.

In January 2017, DOE approved DOE Order 232.2A, *Occurrence Reporting and Processing of Operations Information*, replacing the prior revision, DOE Order 232.2, which had governed occurrence reporting within DOE for many years. The Board issued a letter to DOE on May 10, 2017, that identified several changes to DOE's occurrence reporting process and requirements. The Board determined that these changes would potentially weaken DOE's occurrence reporting. Of particular concern, DOE deleted requirements to report a Potential Inadequacy of the Safety Analysis and to provide timely notification and comprehensive final occurrence reports that include causal analysis information for certain events of safety significance. The Board considered that these changes would impede safety oversight and organizational learning at defense nuclear facilities.

The Board's May 10, 2017, letter noted supplemental efforts within DOE to address these concerns for defense nuclear facilities and requested that DOE report on any supplemental actions planned to ensure safety oversight is not degraded at defense nuclear facilities prior to implementing the revised Order. DOE responded to the Board in a letter dated October 11, 2017. DOE noted that it did not consider that the changes would impede safety oversight, but identified supplemental occurrence reporting actions being taken individually by NNSA, the DOE Office of Environmental Management, and the DOE Office of Science.

Emergency Preparedness, Response, and Recovery

On September 3, 2014, the Board issued Recommendation 2014-1, *Emergency Preparedness and Response*, to address deficiencies in emergency management programs at defense nuclear facilities by strengthening DOE's emergency management requirements and DOE's oversight of compliance with those requirements. Following Recommendation 2014-1, the Board issued Recommendation 2015-1, *Emergency Preparedness and Response at Pantex*, on November 24, 2015, to address significant safety issues specific to Pantex. Appendix A summarizes the status of these recommendations.

The Board noted weaknesses in emergency preparedness and response programs at LANL and sent a Draft Recommendation to the Secretary of Energy on February 21, 2017. Subsequently, based on interactions with DOE, the Board decided not to send a final Recommendation. The Board documented its concerns regarding emergency preparedness and response programs at LANL in a letter to DOE dated October 11, 2017.

Throughout 2017, the Board and its staff reviewed emergency response drills and exercises at Y-12 National Security Complex, Pantex Plant, SRS, WIPP, Nevada National Security Site, Hanford Site, LANL, , and LLNL to evaluate the current competencies and capabilities of emergency response at the defense nuclear facilities.

Conduct of Operations and Maintenance

In 2017, members of the Board's staff continued to assess the conduct of maintenance and operations at DOE's defense nuclear facilities. The Board's staff assessed maintenance programs at the Hanford Site, LLNL, and the Pantex Plant. At the Hanford Site, the Board's staff focused on the adequacy of programmatic documentation and implementing practices that contribute to the operability and reliability of safety-related systems, structures, and components. The Board's staff review at LLNL followed up on maintenance issues identified in a 2015 review. The Board's staff and a Board member followed up on a November 2015 Board letter to NNSA detailing deficiencies in several elements of the Pantex Plant's maintenance program. Pantex has completed most of the corrective actions developed in response to the Board letter. The Pantex Plant maintenance review also evaluated the cognizant system engineering program with a focus on its support of maintenance operations and activities.

Members of the Board's staff evaluated conduct of operations at SRS and LLNL. At SRS, the Board's staff evaluated implementation of technical safety requirements by operations personnel necessary for supporting the safety of operations at SRS defense nuclear facilities. The Board's staff also assessed contractor corrective action plans developed in response to recent inadequate technical safety requirement implementation events. DOE directed improvements to the implementation and control of technical safety requirements. At LLNL, the staff's operations review was focused on the implementation of its operational drill program and the adequacy of the abnormal operating and alarm response procedures.

Appendix A: Board Recommendations

Recommendations Open in 2017

Recommendation 2015-1, *Emergency Preparedness and Response at the Pantex Plant*

The Defense Nuclear Facilities Safety Board (Board) issued Recommendation 2015-1 in November 2015. The Board determined that there were significant weaknesses in specific elements of emergency response at Pantex. The Secretary of Energy accepted the recommendation in a letter dated January 13, 2016, and transmitted the Department of Energy's (DOE) implementation plan to the Board on June 15, 2016. DOE completed the actions in accordance with its implementation plan, with the final set of deliverables transmitted to the Board on June 13, 2017. The Board sent a July 25, 2017, letter to DOE acknowledging receipt of the final deliverables and encouraging DOE to complete its planned series of effectiveness reviews to verify actions taken to address the Board's recommendations. While DOE has implemented many of its implementation plan actions, it has yet to finalize issuance of its revised emergency actions levels and adequately formalize and demonstrate its off-site field monitoring processes.

Recommendation 2014-1, *Emergency Preparedness and Response*

Recommendation 2014-1 called on DOE to standardize and improve its criteria and review approach for oversight to improve emergency management at the defense nuclear facilities and update the emergency management directive. The Board's February 16, 2017, letter to the Secretary of Energy expressed the Board's view that the implementation plan for Recommendation 2014-1 was inadequate and significantly behind schedule, compared to Secretary Moniz's originally stated intention. The Board encouraged DOE to re-visit the implementation plan and revise it to improve performance at sites with defense nuclear facilities in a timelier manner. Subsequently, the Board held a public meeting on September 26, 2017, to discuss the status of DOE's implementation of the Recommendation. At this meeting, the Board voted to close the Recommendation. The Board issued a letter to DOE on December 13, 2017, stating that the Board closed the Recommendation because it concluded that DOE's implementation plan would not adequately address the concerns raised in the Recommendation. The Board requested that DOE brief the Board in early 2018 regarding DOE's assessment of progress made to date to address Board Recommendation 2014-1.

Recommendation 2012-2, *Hanford Tank Farms Flammable Gas Safety Strategy*

Recommendation 2012-2 identified the need for safety-related ventilation systems to aid in preventing flammable gas events in the double-shell tanks at the Hanford Tank Farms. The recommendation also identified the need to upgrade a number of other systems necessary to provide accurate and reliable indications of abnormal conditions associated with flammable gas events.

DOE is now treating the double-shell tank primary ventilation system as a safety-significant control in the safety basis. Additionally, DOE is pursuing design and implementation of two additional safety-related systems in the double-shell tanks: ventilation airflow monitors, and annulus waste level indicators. The Board expects DOE to complete these improvements during 2018. During 2017, the Board's staff reviewed the design of the safety-significant instruments that will be used to transmit wireless signals for both of these systems. The Board did not identify any issues with DOE's approach.

Recommendation 2012-1, *Savannah River Site Building 235-F Safety*

Recommendation 2012-1 identified the need for DOE to take actions to reduce the risk to collocated workers at Building 235-F. These actions include removing or immobilizing the residual contamination within Building 235-F, taking near-term actions to improve the safety posture of the facility, and ensuring the emergency response to a radiological release from Building 235-F is adequate.

The Secretary of Energy provided an implementation plan in response to Recommendation 2012-1 in December 2012 and an updated schedule to the implementation plan in March 2015. DOE's projected overall completion date for mitigating the residual contamination hazard at Building 235-F is May 2021. During 2017, DOE completed restoration of the cell infrastructure in cells 3-5 of the Plutonium Fuel Form Facility, which consisted of window remediation and establishing lighting to support deactivation activities. DOE also completed enhanced characterization measurements in the shift operating base for the highest contaminated cells (cells 1 and 2) to support removal of contamination from those cells.

Recommendation 2011-1, *Safety Culture at the Waste Treatment and Immobilization Plant*

The Board issued Recommendation 2011-1 following an investigation into whistleblower-identified safety concerns at the Waste Treatment and Immobilization Plant Project at the Hanford Site. DOE has completed all commitments identified in its implementation plan. However, DOE site offices and contractors continue to implement the safety culture sustainment plans approved in 2014, and the DOE-wide Safety Culture Improvement Panel, established in 2015. DOE continues to prepare guidance and training material for improving its safety culture. During 2017, the Board's staff monitored efforts by DOE and its contractors to implement safety culture sustainment plans and the activities of the Safety Culture Improvement Panel. The Board's staff also conducted a review of the implementation of Recommendation 2011-1 related actions at the Pantex Plant. The Board's staff plans to conduct an effectiveness review at the Waste Treatment and Immobilization Plant Project in 2018.

Appendix B: Summary of Significant Safety-Related Aging Infrastructure Issues at Defense Nuclear Facilities

This is the Defense Nuclear Facilities Safety Board's (Board) eighth annual report on safety issues associated with aging infrastructure at Department of Energy (DOE) defense nuclear facilities. DOE relies on several defense nuclear facilities that are at or near the end of their projected design life, but still must carry out national security and legacy waste cleanup missions. Additionally, other defense nuclear facilities that no longer have an operating mission still perform safety functions because they serve to confine legacy radiological materials. Age-related degradation impacts the ability of facilities to perform mission-related work and legacy confinement functions safely.

During the past year, DOE continued work to mitigate the risk posed by aging defense nuclear facilities. The Board continues to track changes in conditions and missions for aging defense nuclear facilities. In the past year, the Board issued a letter to DOE, dated May 11, 2017, regarding the safety strategy of the Extended Life Program at the Y-12 National Security Complex.

(Intentionally blank)

AFFIRMATION OF BOARD VOTING RECORD

SUBJECT: 2017 Annual Report to Congress

Doc Control#2018-100-010

The Board, with Board Member(s) Bruce Hamilton, Jessie H. Roberson, Daniel J. Santos *approving*, Board Member(s) Joyce L. Connery *disapproving*, Board Member(s) none *abstaining*, and Board Member(s) none *not participating*, has voted to approve the above document on March 8, 2018.

The votes were recorded as:

	APRVD	DISAPRVD	ABSTAIN	NOT PARTICIPATING*	COMMENT	DATE
Bruce Hamilton	<input checked="" type="checkbox"/>	<input type="checkbox"/>	<input type="checkbox"/>	<input type="checkbox"/>	<input type="checkbox"/>	03/08/18
Jessie H. Roberson	<input checked="" type="checkbox"/>	<input type="checkbox"/>	<input type="checkbox"/>	<input type="checkbox"/>	<input type="checkbox"/>	03/08/18
Daniel J. Santos	<input checked="" type="checkbox"/>	<input type="checkbox"/>	<input type="checkbox"/>	<input type="checkbox"/>	<input type="checkbox"/>	03/08/18
Joyce L. Connery	<input type="checkbox"/>	<input checked="" type="checkbox"/>	<input type="checkbox"/>	<input type="checkbox"/>	<input checked="" type="checkbox"/>	03/08/18

*Reason for Not Participating:

This Record contains a summary of voting on this matter together with the individual vote sheets, views and comments of the Board Members.



Executive Secretary to the Board

Attachments:

1. Voting Summary
2. Board Member Vote Sheets

cc: Board Members
OGC
OGM Records Officer
OTD

**DEFENSE NUCLEAR FACILITIES SAFETY BOARD
NOTATIONAL VOTE RESPONSE SHEET**

FROM: Bruce Hamilton

SUBJECT: Annual Report to Congress

Doc Control#2018-100-010

Approved X Disapproved Abstain

Recusal – Not Participating

COMMENTS: Below Attached None X

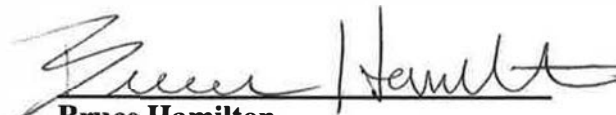
Bruce Hamilton

8 MARCH 2018
Date

DEFENSE NUCLEAR FACILITIES SAFETY BOARD
NOTATIONAL VOTE RESPONSE SHEET

FROM: Jessie Roberson

SUBJECT: Annual Report to Congress

Doc Control#2018-100-010

Approved **Disapproved** **Abstain**
Recusal – Not Participating

COMMENTS: **Below** **Attached** **None**

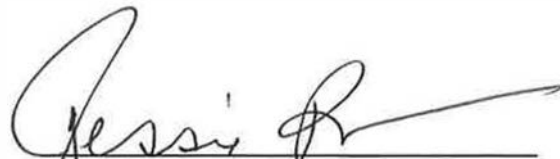
Jessie Roberson
March 8, 2018
Date

DEFENSE NUCLEAR FACILITIES SAFETY BOARD
NOTATIONAL VOTE RESPONSE SHEET

FROM: Daniel J. Santos

SUBJECT: Annual Report to Congress

Doc Control#2018-100-010

Approved X **Disapproved** _____ **Abstain** _____

Recusal – Not Participating _____

COMMENTS: **Below** _____ **Attached** _____ **None** X

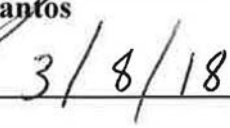

Daniel J. Santos

Date

**DEFENSE NUCLEAR FACILITIES SAFETY BOARD
NOTATIONAL VOTE RESPONSE SHEET**

FROM: Joyce Connery

SUBJECT: Annual Report to Congress

Doc Control#2018-100-010

Approved _____ **Disapproved** x **Abstain** _____

Recusal – Not Participating _____

COMMENTS: **Below** x **Attached** _____ **None** _____

I am only disapproving of this document because there are internal inconsistencies that I would like to see cleaned up before it is issued and a unanimous consent to do so would have failed.

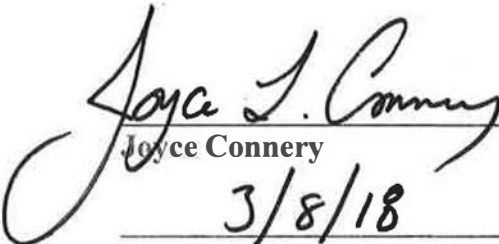

Joyce Connery
3/8/18

Date